

REV.	ECN NO.	MODIFIED MARK	APPROVED
A	—	FIRST RELEASE	

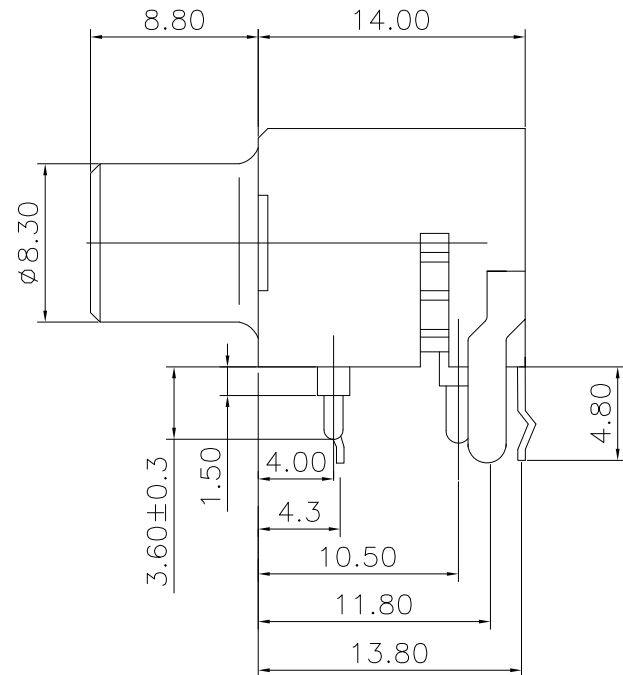

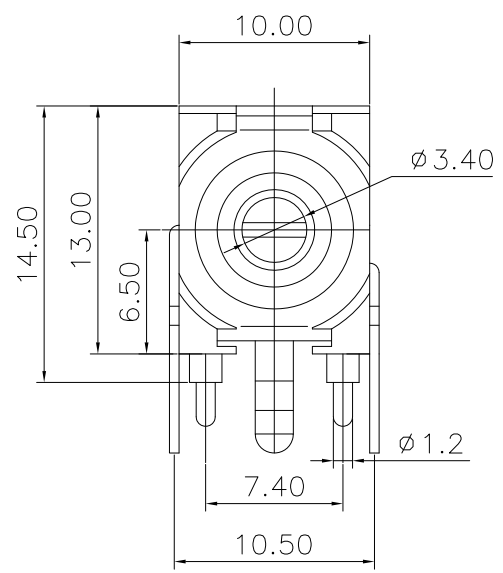

NOTES:
 ELECTRICAL:
 1:RATED CURRENT: 0.2A Max.
 2:RATED VOLTAGE: 50V AC.
 3:CONTACT RESISTANCE: 30 MILLIOHMS Max.
 AFTER TESTING:100 MILLIOHMS Max.
 4:INSULATION RESISTANCE: 100 MEGAOHMS Min.
 5:DIELECTRIC WITHSTANDING VOLTAGE: 500 VAC Min.
 MECHANICAL:
 1:INSERTION FORCE: 3N-30N.
 2:WITHDRAWAL FORCE: 3N-30N.
 3:DURRABILITY: 100 CYCLES.
 ENVIRONMENTAL:
 TEMPERATURE RANGE: -20°C TO 60°C.

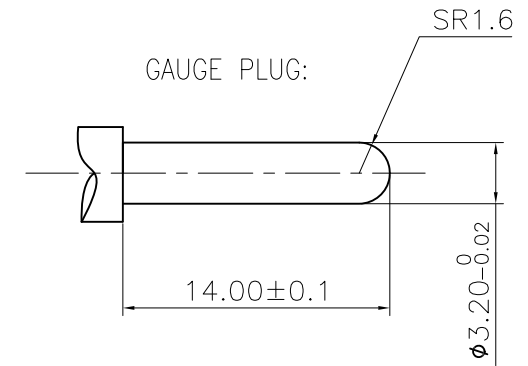
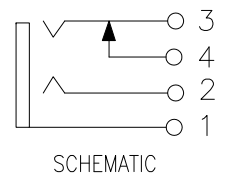
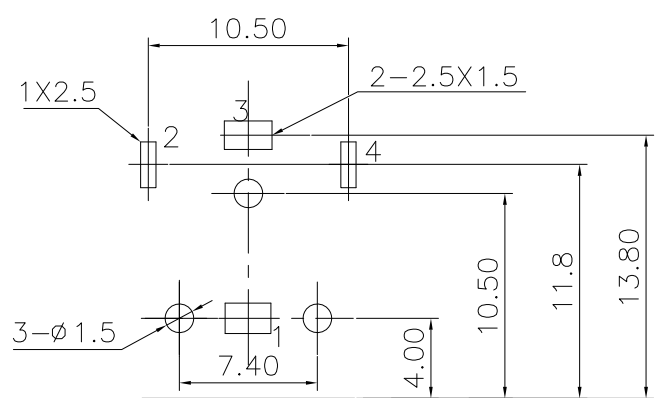

PCB LAYOUT
TOP VIEW

ANGLE	±5°
63 < L	±0.5
16 < L ≤ 63	±0.4
4 < L ≤ 16	±0.3
L ≤ 4	±0.2
TOL TABLE:	
THIS DOCUMENT IS THE PROPERTY OF TRENPRO TECHNOLOGY CO. LTD. NO PART THEREOF MAY BE REPRODUCED AND USED WITHOUT THE PRIOR WRITTEN CONSENT OF THE OWNER	

MODEL NAME: RCA-104D (PART NO.)		 广东正宝科技有限公司 GUANGDONG TRENPRO TECHNOLOGY CO. LTD.	
MAT'L: See table	DESIGN: Z.F.Lian 09/20'18	TITLE: RCA PIN JACK	
FINISH: See table	CHECKED: L.W.Wu 09/20'18	DWG NO.:	REV.: A
Q'TY: /	APPROVED: X.Q.Hu 09/20'18	UNIT: mm	VIEW: 
		SCALE: 5:1	SHEET: 1/1
			SIZE: A3