

|      |         |               |          |
|------|---------|---------------|----------|
| REV. | ECN NO. | MODIFIED MARK | APPROVED |
| A    | —       | FIRST RELEASE |          |

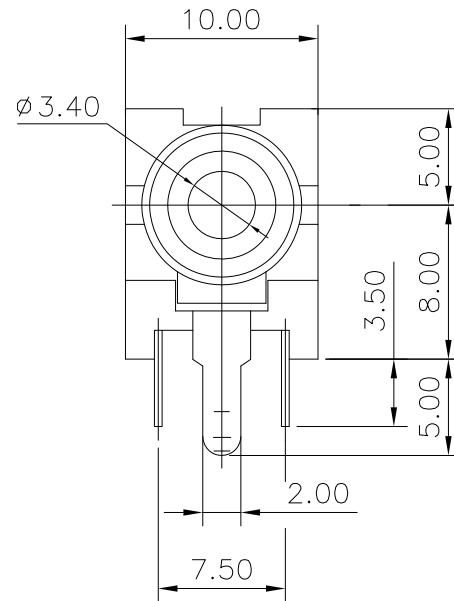

NOTES:  
 ELECTRICAL:  
 1:RATED CURRENT: 0.2A Max.  
 2:RATED VOLTAGE: 50V AC.  
 3:CONTACT RESISTANCE: 30 MILLIOHMS Max.  
 AFTER TESTING:100 MILLIOHMS Max.  
 4:INSULATION RESISTANCE: 100 MEGAOHMS Min.  
 5:DIELECTRIC WITHSTANDING VOLTAGE: 500 VAC Min.  
 MECHANICAL:  
 1:INSERTION FORCE: 3N-30N.  
 2:WITHDRAWAL FORCE: 3N-30N.  
 3:DURRABILITY: 100 CYCLES.  
 ENVIRONMENTAL:  
 TEMPERATURE RANGE: -20°C TO 60°C.

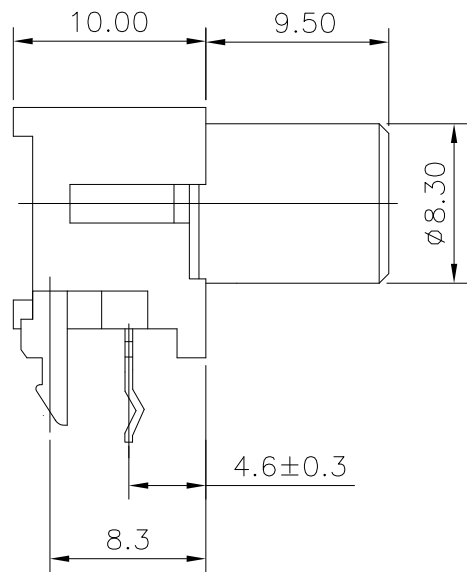

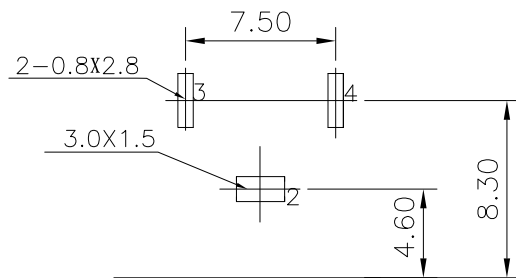

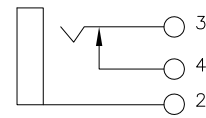
PCB LAYOUT  
TOP VIEW

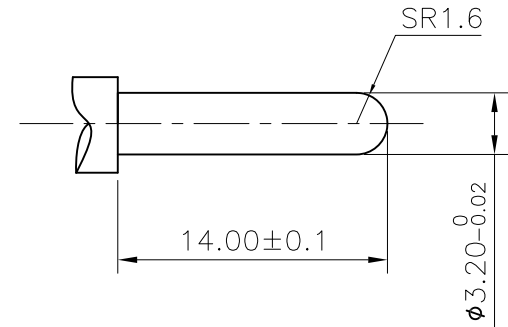

SCHEMATIC

GAUGE PLUG:



|  |      |                                    |   |   |            |            |          |
|--|------|------------------------------------|---|---|------------|------------|----------|
| ANGLE  | ±5°  | MODEL NAME: RCA-105C<br>(PART NO.) |  广东正宝科技有限公司<br>GUANGDONG TRENPRO TECHNOLOGY CO. LTD. |   |            |            |          |
| 63 < L   | ±0.5 |                                    |   |   |            |            |          |
| 16 < L ≤ 63  | ±0.4 |                                    |   |   |            |            |          |
| 4 < L ≤ 16   | ±0.3 |                                    |   |   |            |            |          |
| L ≤ 4  | ±0.2 |                                    |   |   |            |            |          |
| TOL TABLE:   |      | MAT'L:<br>See table                | DESIGN: Z.F.Lian 09/20'18   | TITLE: RCA PIN JACK   |            |            |          |
| THIS DOCUMENT IS THE PROPERTY OF TRENPRO TECHNOLOGY CO. LTD. NO PART THEREOF MAY BE REPRODUCED AND USED WITHOUT THE PRIOR WRITTEN CONSENT OF THE OWNER |      | FINISH:<br>See table               | CHECKED: L.W.Wu 09/20'18  | DWG NO.:  | REV.:<br>A |            |          |
| Q'TY: /  |      | APPROVED: X.Q.Hu 09/20'18          | UNIT: mm  | VIEW:  | SCALE: 5:1 | SHEET: 1/1 | SIZE: A3 |