

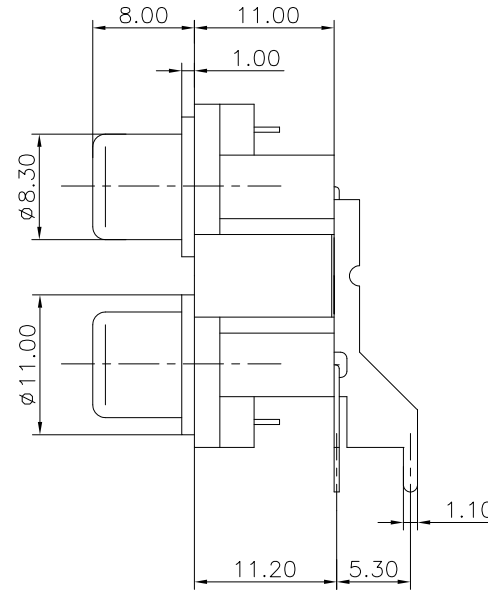

| | | | |
|------|---------|---------------|----------|
| REV. | ECN NO. | MODIFIED MARK | APPROVED |
| A | — | FIRST RELEASE | |

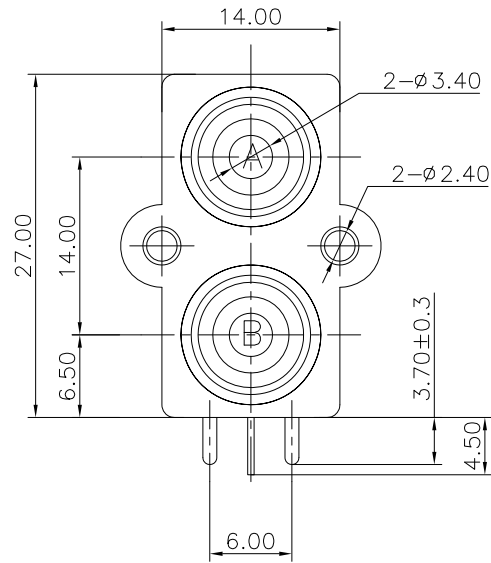

NOTES:
 ELECTRICAL:
 1:RATED CURRENT: 0.2A Max.
 2:RATED VOLTAGE: 50V AC.
 3:CONTACT RESISTANCE: 30 MILLIOHMS Max.
 AFTER TESTING:100 MILLIOHMS Max.
 4:INSULATION RESISTANCE: 100 MEGAOHMS Min.
 5:DIELECTRIC WITHSTANDING VOLTAGE: 500 VAC Min.
 MECHANICAL:
 1:INSERTION FORCE: 3N-30N.
 2:WITHDRAWAL FORCE: 3N-30N.
 3:DURRABILITY: 100 CYCLES.
 ENVIRONMENTAL:
 TEMPERATURE RANGE: -20°C TO 60°C.

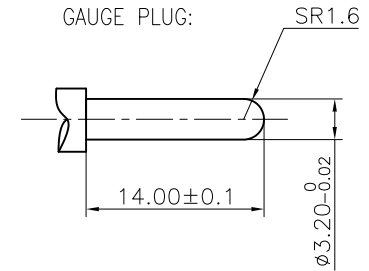
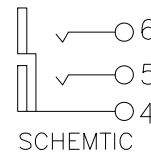
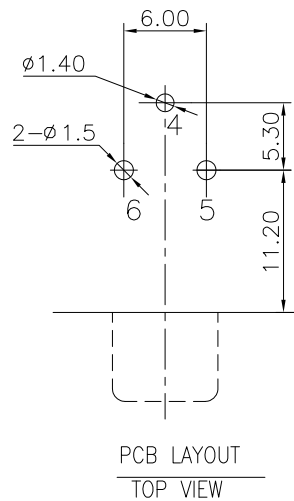

| | | | | | |
|--|------|-----------------------------------|---|---|------------|
| ANGLE | ±5° | MODEL NAME: RCA-207 (PART NO.) |  广东正宝科技有限公司 GUANGDONG TRENPRO TECHNOLOGY CO. LTD. | | |
| 63 < L | ±0.5 | | | | |
| 16 < L ≤ 63 | ±0.4 | | | | |
| 4 < L ≤ 16 | ±0.3 | | | | |
| L ≤ 4 | ±0.2 | | | | |
| TOL TABLE: | | MAT'L: See table | DESIGN: X.H.Wang 11/02'18 | TITLE: RCA PIN JACK | |
| THIS DOCUMENT IS THE PROPERTY OF TRENPRO TECHNOLOGY CO. LTD.,NO PART THEREOF MAY BE REPRODUCED AND USED WITHOUT THE PRIOR WRITTEN CONSENT OF THE OWNER | | FINISH: See table | CHECKED: L.W.Wu 11/02'18 | DWG NO.: | REV.: A |
| Q'TY: / | | APPROVED: X.Q.Hu 11/02'18 | UNIT: mm | VIEW:  | SCALE: 5:1 |
| | | | | SHEET: 1/1 | SIZE: A3 |