

REV.	ECN NO.	MODIFIED MARK	APPROVED
A	—	FIRST RELEASE	

NOTES:
 ELECTRICAL:
 1:RATED CURRENT: 0.2A Max.
 2:RATED VOLTAGE: 50V AC.
 3:CONTACT RESISTANCE: 30 MILLIOHMS Max.
 AFTER TESTING:100 MILLIOHMS Max.
 4:INSULATION RESISTANCE: 100 MEGAOHMS Min.
 5:DIELECTRIC WITHSTANDING VOLTAGE: 500 VAC Min.
 MECHANICAL:
 1:INSERTION FORCE: 3N-30N.
 2:WITHDRAWAL FORCE: 3N-30N.
 3:DURRABILITY: 100 CYCLES.
 ENVIRONMENTAL:
 TEMPERATURE RANGE: -20°C TO 60°C.

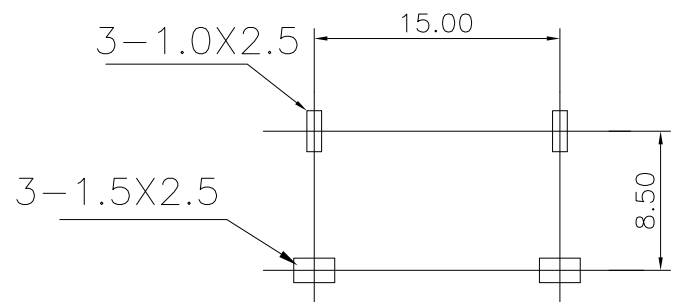

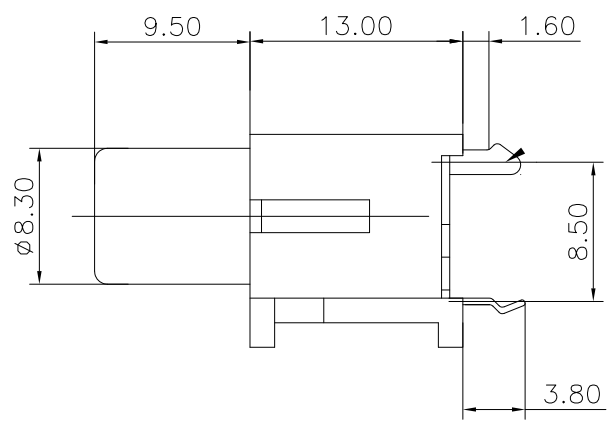
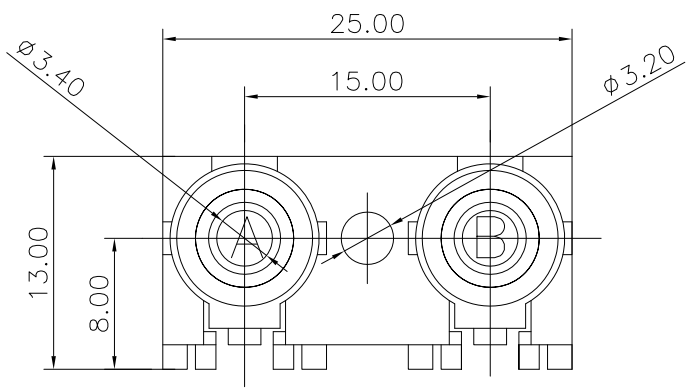
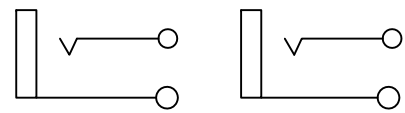

PCB LAYOUT
TOP VIEW

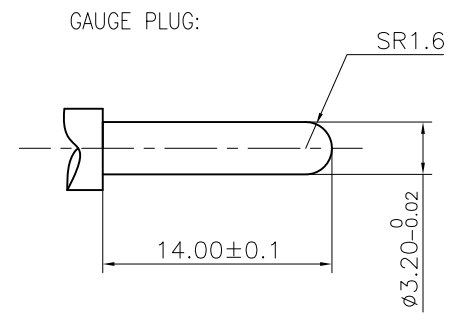

SCHEMATIC



ANGLE	±5°	MODEL NAME: RCA-220 (PART NO.)		 广东正宝科技有限公司 GUANGDONG TRENPRO TECHNOLOGY CO., LTD.	
63 < L	±0.5	MAT'L:	DESIGN:X.H.Wang 12/11'18	TITLE: RCA PIN JACK	
16 < L ≤ 63	±0.4	See table			
4 < L ≤ 16	±0.3	FINISH:	CHECKED:L.W.Wu 12/11'18	DWG NO.:	REV.:
L ≤ 4	±0.2	See table			A
TOL TABLE:		Q'TY: /	APPROVEDX.Q.Hu 12/11'18	UNIT: mm	VIEW: 
<small>THIS DOCUMENT IS THE PROPERTY OF TRENPRO TECHNOLOGY CO., LTD.NO PART THEREOF MAY BE REPRODUCED AND USED WITHOUT THE PRIOR WRITTEN CONSENT OF THE OWNER</small>					
		SCALE: 5:1	SHEET: 1/1	SIZE: A3	