

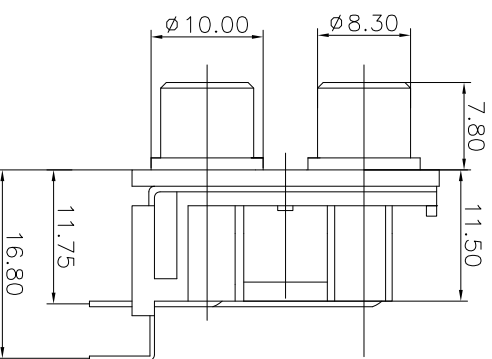

REV.	ECN NO.	MODIFIED MARK	APPROVED
A		FIRST RELEASE	

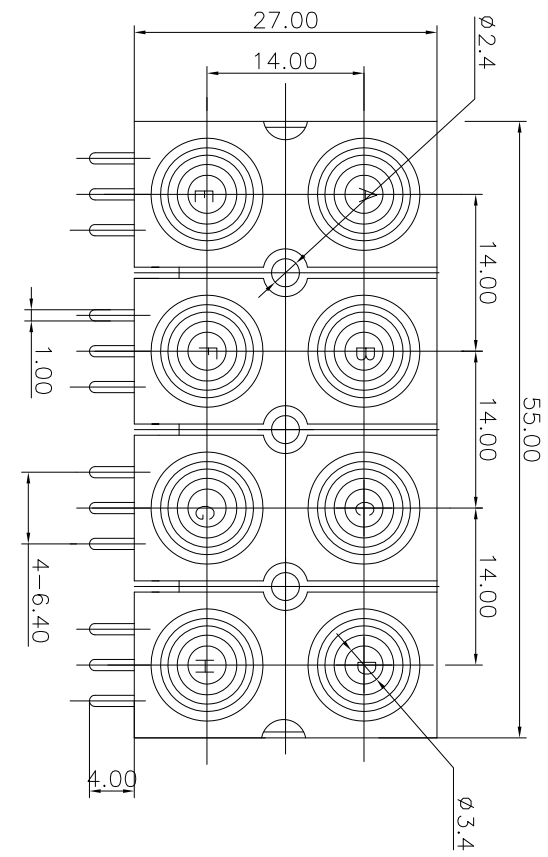

- NOTES:
- ELECTRICAL:
- 1: RATED CURRENT: 0.2A Max.
  - 2: RATED VOLTAGE: 50V AC.
  - 3: CONTACT RESISTANCE: 30 MILLIOHMS Max.
  - 4: AFTER TESTING: 100 MILLIOHMS Max.
  - 5: INSULATION RESISTANCE: 100 MEGAOHMS Min.
- MECHANICAL:
- 1: INSERTION FORCE: 3N-30N.
  - 2: WITHDRAWAL FORCE: 3N-30N.
  - 3: DURABILITY: 100 CYCLES.
- ENVIRONMENTAL:
- TEMPERATURE RANGE: -20°C TO 60°C.

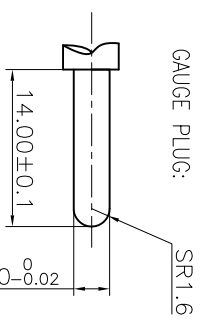
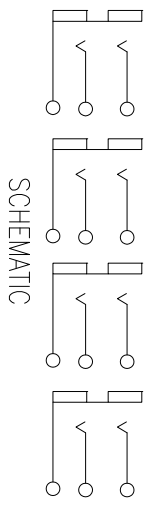
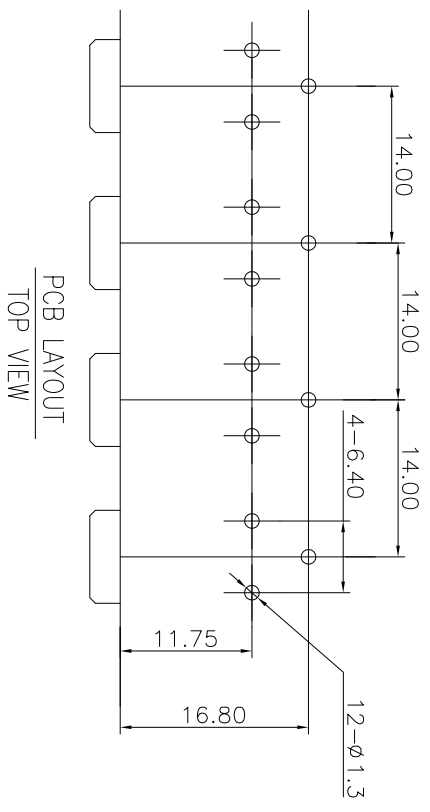

ANGLE	±5°	MODEL NAME: RCA-811	 广东正宝科技有限公司 GUANGDONG TRENPRO TECHNOLOGY CO., LTD.
63 < L	±0.5	(PART NO.)	
16 < L ≤ 63	±0.4	DESIGN: X.H.Wang	TITLE: RCA PIN JACK
4 < L ≤ 16	±0.3	CHECKED: L.W.Wu	DWG NO.:
L ≤ 4	±0.2	See table	DATE: 11/24'18
TOL TABLE:		FINISH: See table	UNIT: mm
THIS DOCUMENT IS THE PROPERTY OF TRENPRO TECHNOLOGY CO., LTD. NO PART THEREOF MAY BE REPRODUCED AND USED WITHOUT THE PRIOR WRITTEN CONSENT OF THE OWNER.		Q'TY: /	APPROVED: X.Q.Hu
		DATE: 11/24'18	SCALE: 5:1
		VIEW: 	SHEET: 1/1
		SIZE: A3	REV.: A

PCB LAYOUT  
TOP VIEW

SCHEMATIC

GAUGE PLUG:

SR1.6