

REV.	ECN NO.	MODIFIED MARK	APPROVED
A	—	FIRST RELEASE	

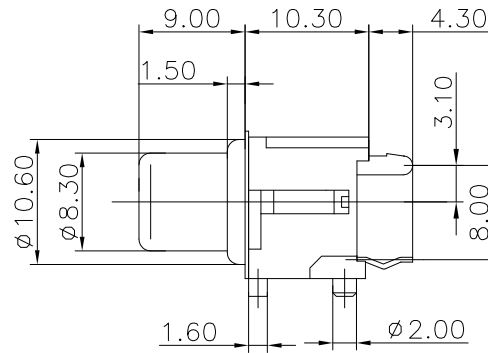
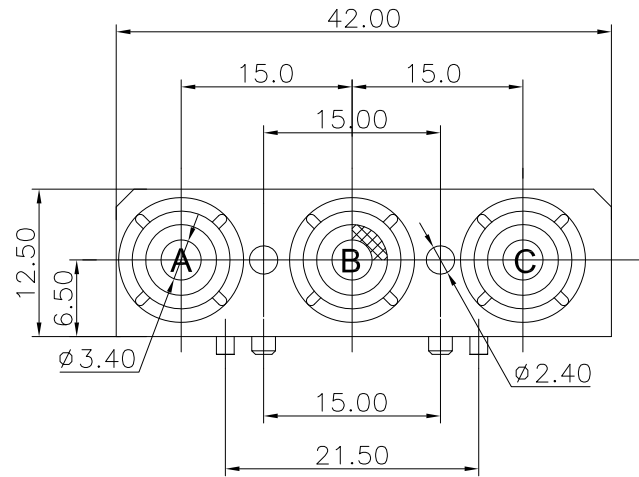

NOTES:

ELECTRICAL:

- 1: RATED CURRENT: 0.2A Max.
- 2: RATED VOLTAGE: 50V AC.
- 3: CONTACT RESISTANCE: 30 MILLIOHMS Max.
AFTER TESTING: 100 MILLIOHMS Max.
- 4: INSULATION RESISTANCE: 100 MEGAOHMS Min.
- 5: DIELECTRIC WITHSTANDING VOLTAGE: 500 VAC Min.

MECHANICAL:

- 1: INSERTION FORCE: 3N-30N.
 - 2: WITHDRAWAL FORCE: 3N-30N.
 - 3: DURRABILITY: 100 CYCLES.
- ENVIRONMENTAL:
TEMPERATURE RANGE: -20°C TO 60°C.

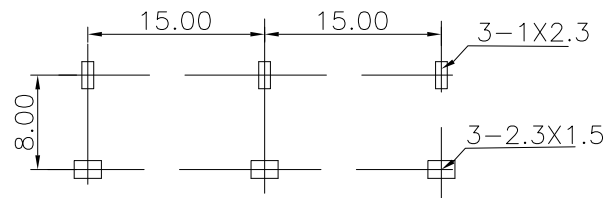

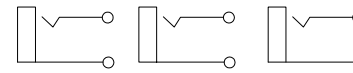

PCB LAYOUT
TOP VIEW

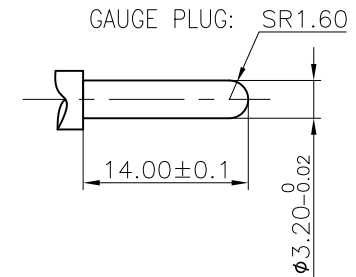

SCHEMATIC



ANGLE	±5°	MODEL NAME: RCA-316A/P (PART NO.)	 广东正宝科技有限公司 GUANGDONG TRENPRO TECHNOLOGY CO. LTD.				
63 < L	±0.5						
16 < L ≤ 63	±0.4						
4 < L ≤ 16	±0.3						
L ≤ 4	±0.2						
TOL TABLE:		MAT'L: See table	DESIGN: Z.F.Lian 09/07'18	TITLE: RCA PIN JACK			
THIS DOCUMENT IS THE PROPERTY OF ZHENGWEI ELECTRONICS CO.,LTD. NO PART THEREOF MAY BE REPRODUCED AND USED WITHOUT THE PRIOR WRITTEN CONSENT OF THE OWNER		FINISH: See table	CHECKED: L.W.Wu 09/07'18	DWG NO.:		REV.: A	
Q'TY: /		APPROVED: X.Q.Hu 09/07'18	UNIT: mm	VIEW: 	SCALE: 5:1	SHEET: 1/1	SIZE: A3